

# HID10N65T-SA

## 650V N-Channel Trench Field Stop IGBT

### Features

- Very Low  $V_{CE(sat)}$
- Extremely low switching loss
- Excellent stability and uniformity
- Soft Fast Reverse Recovery Diode
- Short Circuit Withstand Time 5.0  $\mu s$
- Maximum Junction temperature,  $T_{J(max)}=175^{\circ}C$

### Application

- Uninterruptible Power Supplies (UPS)
- Solar / Welding converters
- Motor drivers
- High frequency Converters

### Key Parameters

Parameter	Value	Unit
$V_{CES}$	650	V
$I_C$	10	A
$V_{CE(sat)}$	1.38	V
$E_{tot}$	0.204	mJ

### Package & Internal Circuit

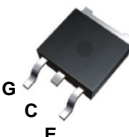
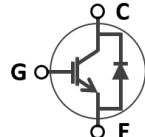
D-PAK	SYMBOL
	

### Absolute Maximum Ratings $T_C=25^{\circ}C$ unless otherwise specified

Symbol	Parameter	Value	Unit
$V_{CES}$	Collector-Emitter Voltage	650	V
$V_{GE}$	Gate-Emitter Voltage	$\pm 20$	V
$I_C$	Collector Current ( @ $T_C = 25^{\circ}C$ ) ( @ $T_C = 100^{\circ}C$ )	20	A
		10	A
$I_{CM}$	Pulsed Collector Current (Note. 1)	40	A
$I_F$	Diode Continuous Forward Current ( @ $T_C = 100^{\circ}C$ )	10	A
$I_{FM}$	Diode Maximum Forward Current	40	A
$P_D$	Power Dissipation ( @ $T_C = 25^{\circ}C$ ) ( @ $T_C = 100^{\circ}C$ )	81	W
		40	W
$T_J$	Maximum Operating Junction Temperature	175	$^{\circ}C$
$T_{STG}$	Storage Temperature Range	-55 to +175	$^{\circ}C$

### Thermal Resistance Characteristics

Symbol	Parameter	Value	Unit
$R_{\theta JC}$	IGBT Thermal Resistance, Junction-to-Case, Max.	1.84	$^{\circ}C/W$
$R_{\theta JC}$	Diode Thermal Resistance, Junction-to-Case, Max.	2.4	$^{\circ}C/W$
$R_{\theta JA}$	Thermal Resistance, Junction-to-Ambient, Max.	40	$^{\circ}C/W$

**Notes** : 1. Repetitive Rating, Pulse width limited by maximum junction temperature

**Electrical Characteristics**  $T_J=25^{\circ}\text{C}$  unless otherwise specified

Symbol	Parameter	Test Conditions	Min	Typ	Max	Unit
<b>Static Characteristics</b>						
$BV_{CES}$	Collector-Emitter Breakdown Voltage	$V_{GE} = 0\text{ V}, I_C = 250\ \mu\text{A}$	650	-	-	V
$I_{CES}$	Zero Gate Voltage Collector Current	$V_{CE} = 650\text{ V}, V_{GE} = 0$ $T_J = 25^{\circ}\text{C}$ $T_J = 150^{\circ}\text{C}$	- -	- 300	30 -	$\mu\text{A}$
$I_{GES}$	Gate Leakage Current	$V_{GE} = \pm 20\text{ V}, V_{CE} = 0\text{ V}$	-	-	$\pm 100$	nA
$V_{GE(th)}$	Gate-Emitter Threshold Voltage	$V_{CE} = V_{GE}, I_C = 250\ \mu\text{A}$	4.2	5.0	5.8	V
$V_{CE(SAT)}$	Collector-Emitter Saturation Voltage	$V_{GE} = 15\text{ V}, I_C = 5\text{ A},$ $T_J = 25^{\circ}\text{C}$ $T_J = 175^{\circ}\text{C}$	- -	1.11 1.12	- -	V
		$V_{GE} = 15\text{ V}, I_C = 10\text{ A},$ $T_J = 25^{\circ}\text{C}$ $T_J = 150^{\circ}\text{C}$ $T_J = 175^{\circ}\text{C}$	- -	1.37 1.52 1.55	1.80 - -	
$V_{FEC}$	Diode Forward Voltage	$V_{GE} = 0\text{ V}, I_F = 5\text{ A},$ $T_J = 25^{\circ}\text{C}$ $T_J = 175^{\circ}\text{C}$	- -	1.35 1.33	- -	V
		$V_{GE} = 0\text{ V}, I_F = 10\text{ A},$ $T_J = 25^{\circ}\text{C}$ $T_J = 175^{\circ}\text{C}$	- -	1.70 1.80	2.20 -	
$g_{fs}$	Transconductance	$V_{CE} = 10\text{ V}, I_C = 10\text{ A}$	-	4.9	-	S
<b>Dynamic Characteristics</b>						
$C_{ies}$	Input Capacitance	$V_{CE} = 25\text{ V}, V_{GE} = 0\text{ V},$ $f = 1.0\text{ MHz}$	-	745	-	pF
$C_{oes}$	Output Capacitance		-	31	-	pF
$C_{res}$	Reverse Transfer Capacitance		-	7.7	-	pF
$Q_g$	Total Gate Charge	$V_{CE} = 520\text{ V}, I_C = 10\text{ A},$ $V_{GE} = 15\text{ V}$	-	25	-	nC
$t_{SC}$	Short Circuit Withstand Time	$V_{CE} = 400\text{ V}, V_{GE} = 15\text{ V}$ $T_J = 100^{\circ}\text{C}$	5.0	-	-	$\mu\text{s}$

**Electrical Characteristics**  $T_J=25^\circ\text{C}$  unless otherwise specified

Symbol	Parameter	Test Conditions	Min	Typ	Max	Unit
<b>Switching Characteristics</b>						
$t_{d(on)}$	Turn-On Time	$V_{CE} = 400\text{ V}, I_C = 10\text{ A},$ $R_G = 10\ \Omega, V_{GE} = 0 / 15\text{ V}$ (Note. 2)	-	59	-	ns
$t_r$	Turn-On Rise Time		-	10.5	-	ns
$t_{d(off)}$	Turn-Off Delay Time		-	100	-	ns
$t_f$	Turn-Off Fall Time		-	41	-	ns
$E_{on}$	Turn-On Energy Loss		-	0.018	-	mJ
$E_{off}$	Turn-Off Energy Loss		-	0.186	-	mJ
$E_{tot}$	Total Energy Loss		-	0.204	-	mJ
$t_{d(on)}$	Turn-On Time	$V_{CE} = 400\text{ V}, I_C = 10\text{ A},$ $R_G = 10\ \Omega, V_{GE} = 0 / 15\text{ V}$ $T_J = 150\ ^\circ\text{C}$ (Note. 2)	-	58	-	ns
$t_r$	Turn-On Rise Time		-	11	-	ns
$t_{d(off)}$	Turn-Off Delay Time		-	125	-	ns
$t_f$	Turn-Off Fall Time		-	62	-	ns
$E_{on}$	Turn-On Energy Loss		-	0.026	-	mJ
$E_{off}$	Turn-Off Energy Loss		-	0.262	-	mJ
$E_{tot}$	Total Energy Loss		-	0.288	-	mJ
$t_{d(on)}$	Turn-On Time	$V_{CE} = 400\text{ V}, I_C = 15\text{ A},$ $R_G = 10\ \Omega, V_{GE} = 0 / 15\text{ V}$ (Note. 2)	-	60	-	ns
$t_r$	Turn-On Rise Time		-	11.9	-	ns
$t_{d(off)}$	Turn-Off Delay Time		-	90	-	ns
$t_f$	Turn-Off Fall Time		-	41	-	ns
$E_{on}$	Turn-On Energy Loss		-	0.025	-	mJ
$E_{off}$	Turn-Off Energy Loss		-	0.275	-	mJ
$E_{tot}$	Total Energy Loss		-	0.300	-	mJ

**Notes** : 2. Include tail current and diode reverse recovery.

**Electrical Characteristics**  $T_J=25^\circ\text{C}$  unless otherwise specified

Symbol	Parameter	Test Conditions	Min	Typ	Max	Unit
<b>Switching Characteristics</b>						
$t_{d(on)}$	Turn-On Time	$V_{CE} = 400\text{ V}$ , $I_C = 15\text{ A}$ , $R_G = 10\ \Omega$ , $V_{GE} = 0 / 15\text{ V}$ $T_J = 150\ ^\circ\text{C}$ (Note. 2)	-	61	-	ns
$t_r$	Turn-On Rise Time		-	12.5	-	ns
$t_{d(off)}$	Turn-Off Delay Time		-	108	-	ns
$t_f$	Turn-Off Fall Time		-	55	-	ns
$E_{on}$	Turn-On Energy Loss		-	0.033	-	mJ
$E_{off}$	Turn-Off Energy Loss		-	0.380	-	mJ
$E_{tot}$	Total Energy Loss		-	0.413	-	mJ
<b>Diode Reverse Recovery Characteristics</b>						
$t_{rr}$	Diode Reverse Recovery Time	$V_R = 400\text{ V}$ , $I_F = 10\text{ A}$ , $di/dt = 1,000\text{ A}/\mu\text{s}$	-	58.5	-	ns
$I_{rr}$	Diode Reverse Recovery Current		-	9.7	-	A
$Q_{rr}$	Diode Reverse Recovery Charge		-	0.289	-	$\mu\text{C}$
$t_{rr}$	Diode Reverse Recovery Time	$V_R = 400\text{ V}$ , $I_F = 10\text{ A}$ , $T_J = 150\ ^\circ\text{C}$ $di/dt = 1,000\text{ A}/\mu\text{s}$	-	70	-	ns
$I_{rr}$	Diode Reverse Recovery Current		-	12.4	-	A
$Q_{rr}$	Diode Reverse Recovery Charge		-	0.492	-	$\mu\text{C}$

**Notes** : 2. Include tail current and diode reverse recovery.

### IGBT Static Characteristics Figure.

Figure.1 Saturation Voltage characteristics ,Junction Temperature( $T_J$ ) 25°C

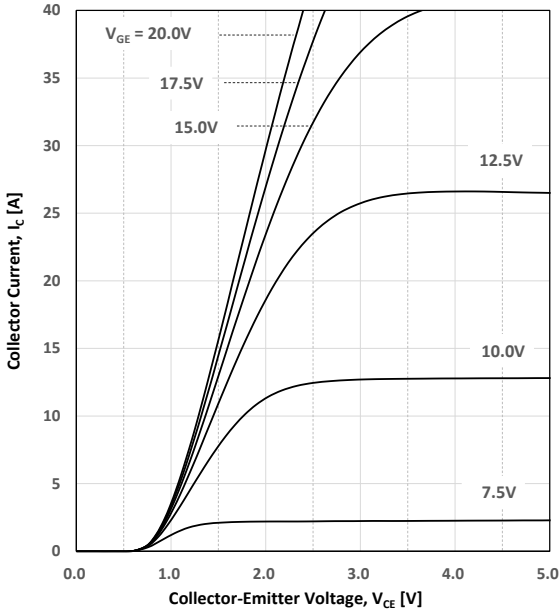

Figure.2 Saturation Voltage characteristics ,Junction Temperature( $T_J$ ) 150°C

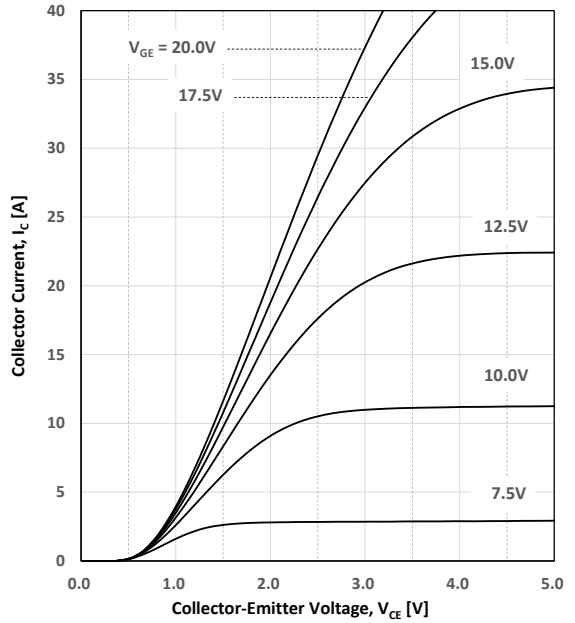

Figure.3 Saturation Voltage characteristics as Junction Temperature,  $V_{GE}=15V$

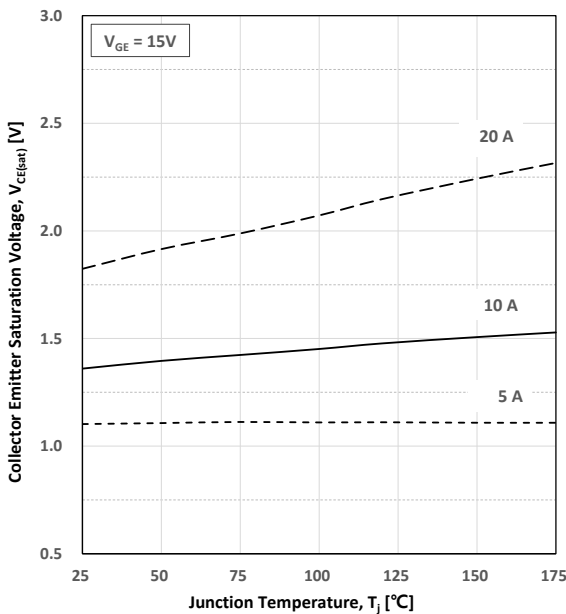

Figure.4 Transconductance characteristics as Junction Temperature,  $V_{CE}=10V$

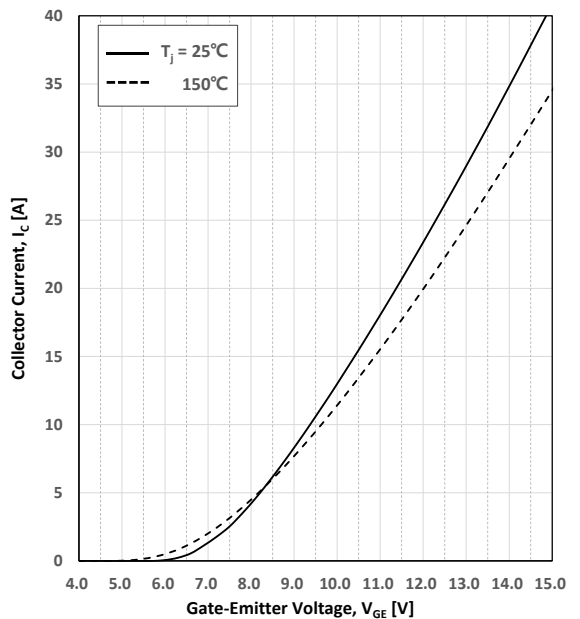

Figure.5 Threshold Voltage characteristics as Junction Temperature

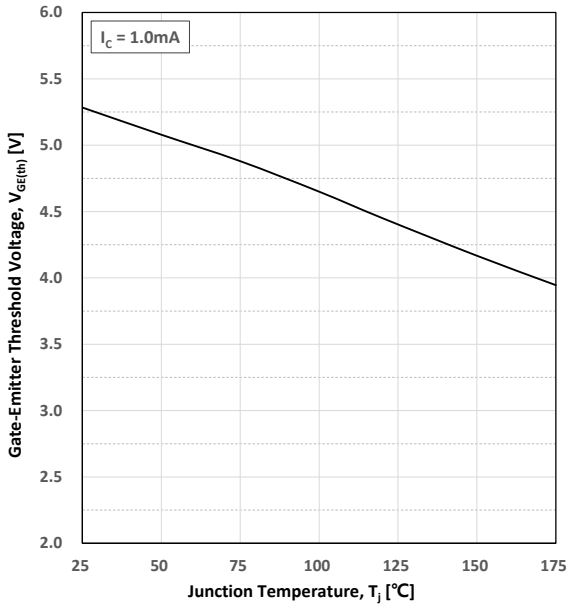
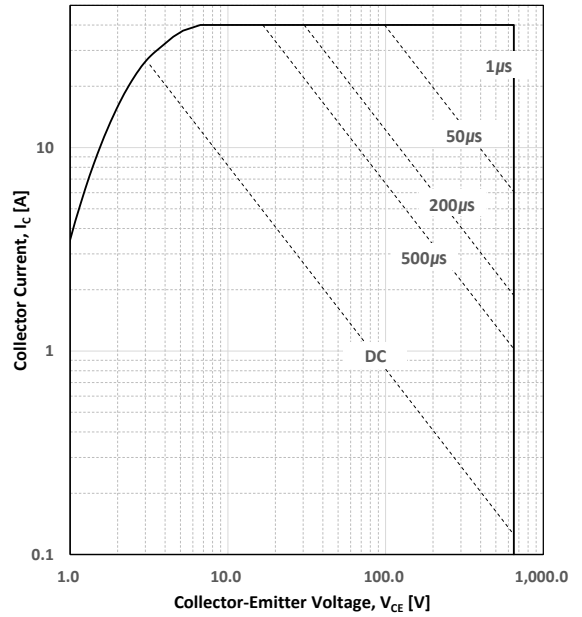

Figure.6 Forward Bias Safe Operating Area ( $T_c=25^\circ C, T_j \le 175^\circ C, V_{GE} \ge 15V, t_p=1\mu s, D=0$ )



### IGBT Dynamic Characteristics Figure.

Figure.7 Capacitance characteristics ( $f=1MHz$ )

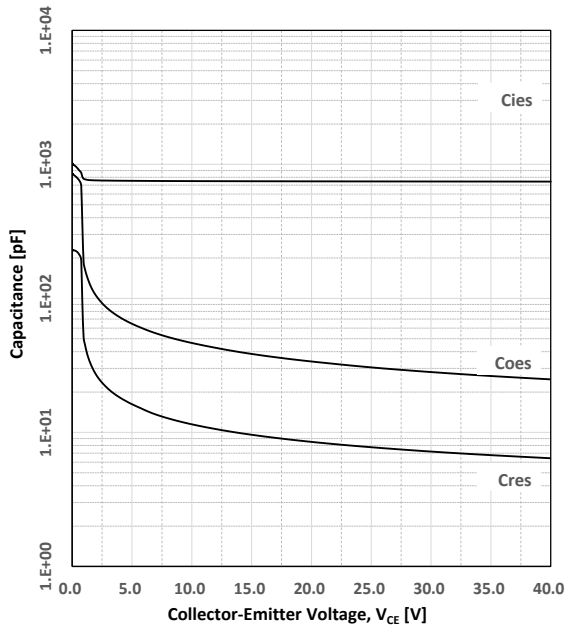
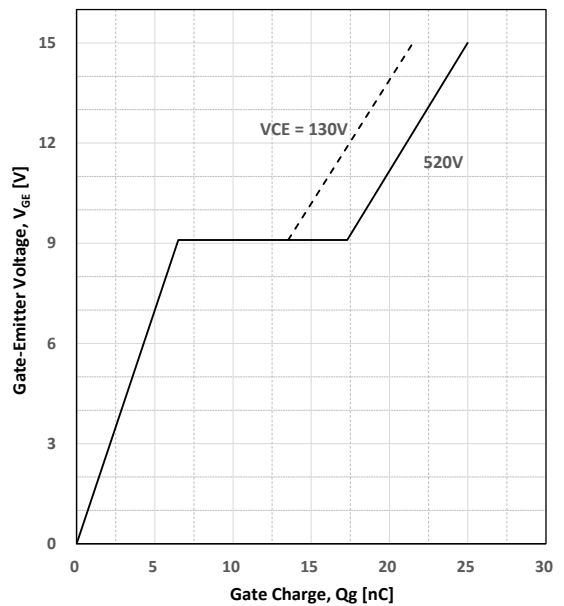

Figure.8 Gate Charge characteristics ( $I_c=10A$ )



### IGBT Switching Characteristics Figure.

Figure.9 Switching Times as Gate Resistance  
 ( $V_{CE}=400V, I_C=10A, V_{GE}=15V, T_J=25^\circ C$ )

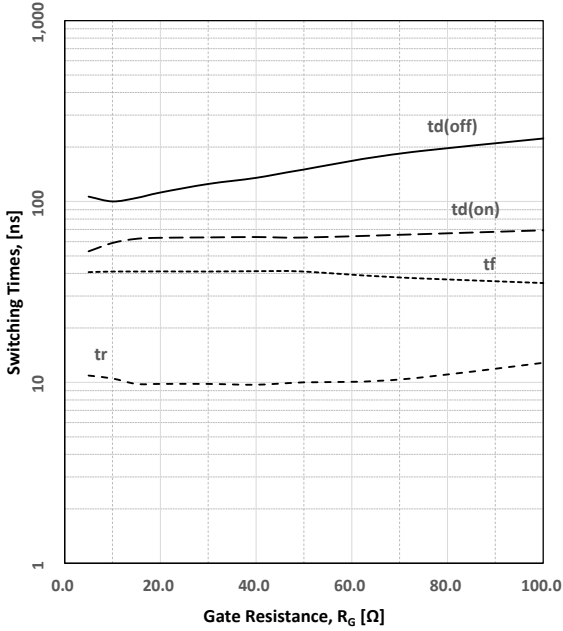

Figure.10 Switching Loss as Gate Resistance  
 ( $V_{CE}=400V, I_C=10A, V_{GE}=15V, T_J=25^\circ C$ )

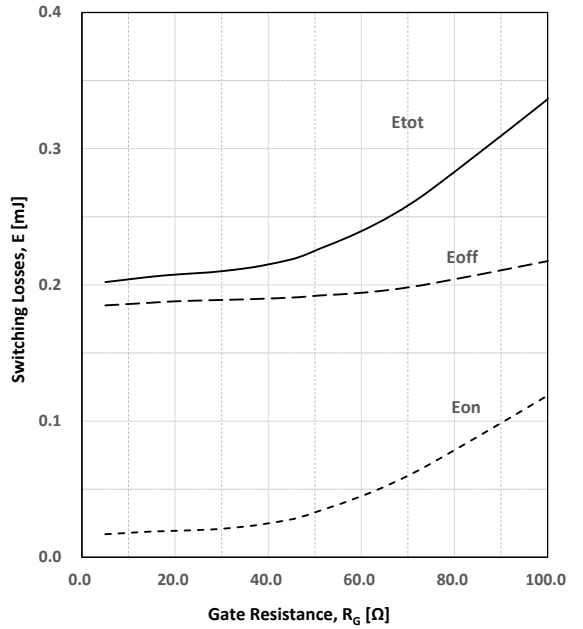

Figure.11 Switching Times as Collector Current  
 ( $V_{CE}=400V, V_{GE}=15V, R_g=10\Omega, T_J=25^\circ C$ )

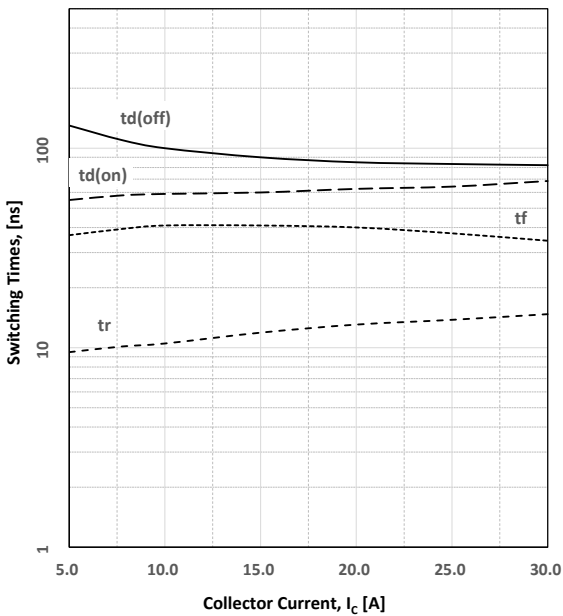

Figure.12 Switching Loss as Collector Current  
 ( $V_{CE}=400V, V_{GE}=15V, R_g=10\Omega, T_J=25^\circ C$ )

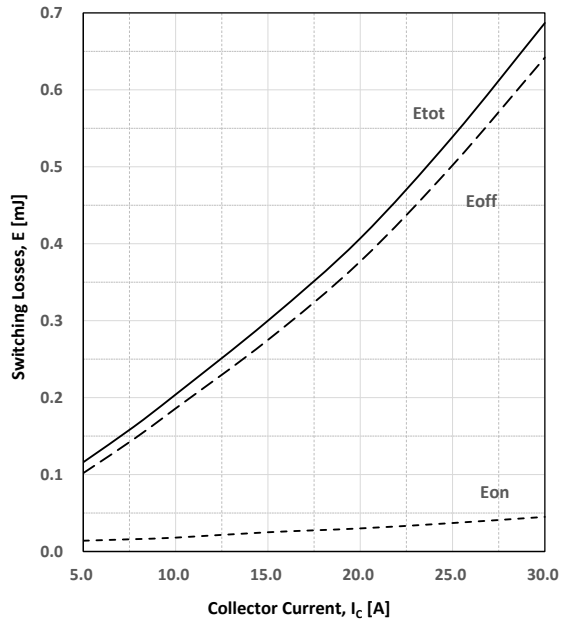

Figure.13 Switching Times as Collector Voltage  
 ( $I_C=10A$ ,  $V_{GE}=15V$ ,  $R_g=10\Omega$ ,  $T_J=25^\circ C$ )

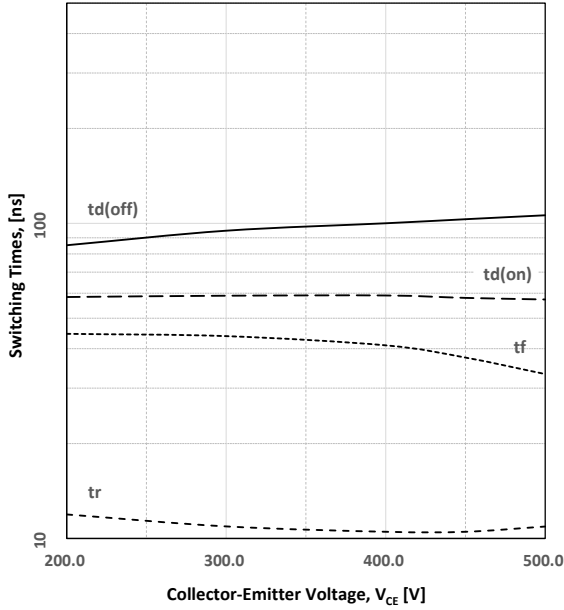

Figure.14 Switching Loss as Collector Voltage  
 ( $I_C=10A$ ,  $V_{GE}=15V$ ,  $R_g=10\Omega$ ,  $T_J=25^\circ C$ )

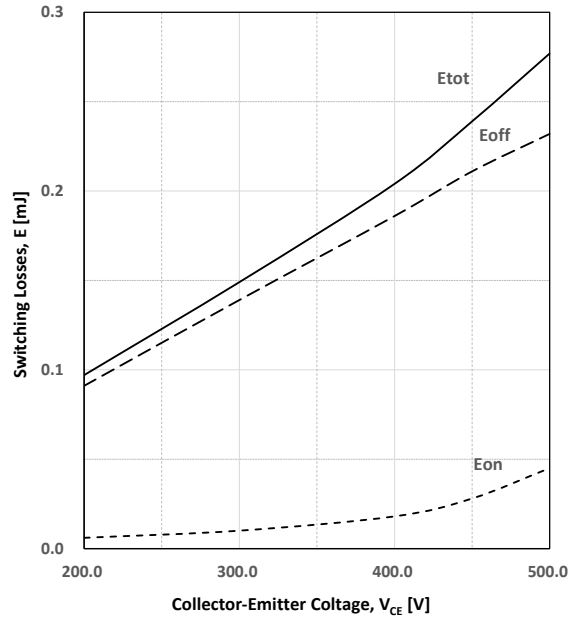

Figure.15 Switching Times as Gate Resistance  
 ( $V_{CE}=400V$ ,  $I_C=10A$ ,  $V_{GE}=15V$ ,  $T_J=150^\circ C$ )

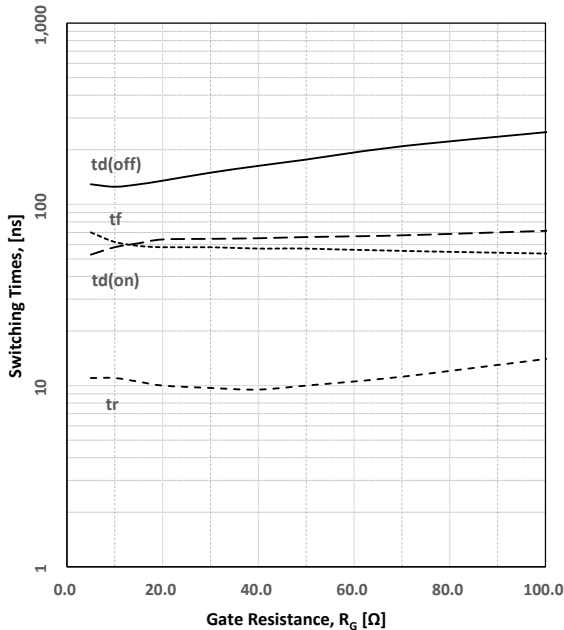

Figure.16 Switching Loss as Gate Resistance  
 ( $V_{CE}=400V$ ,  $I_C=10A$ ,  $V_{GE}=15V$ ,  $T_J=150^\circ C$ )

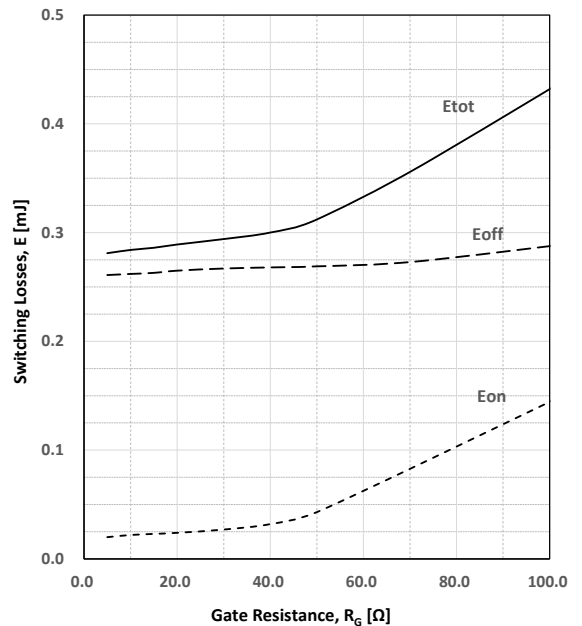



Figure.17 Switching Times as Collector Current  
 ( $V_{CE}=400V, V_{GE}=15V, R_g=10\Omega, T_J=150^\circ C$ )

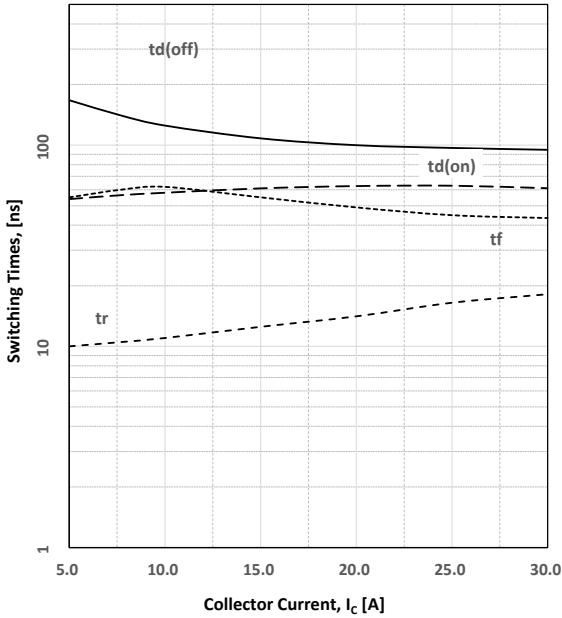

Figure.18 Switching Loss as Collector Current  
 ( $V_{CE}=400V, V_{GE}=15V, R_g=10\Omega, T_J=150^\circ C$ )

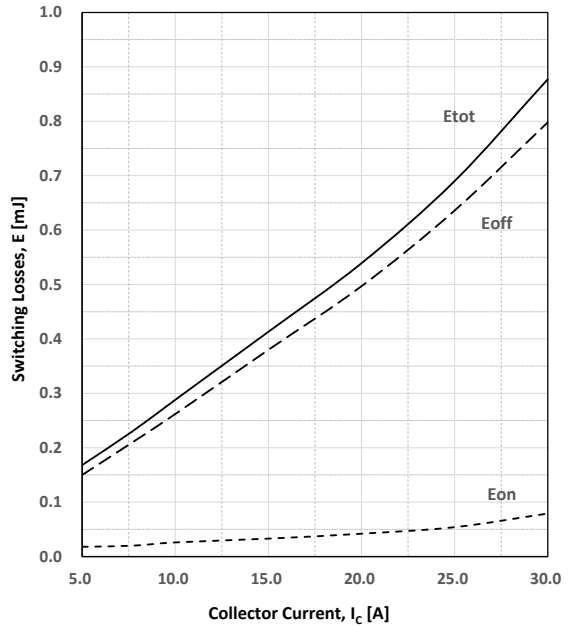

Figure.19 Switching Times as Collector Voltage  
 ( $I_C=10A, V_{GE}=15V, R_g=10\Omega, T_J=150^\circ C$ )

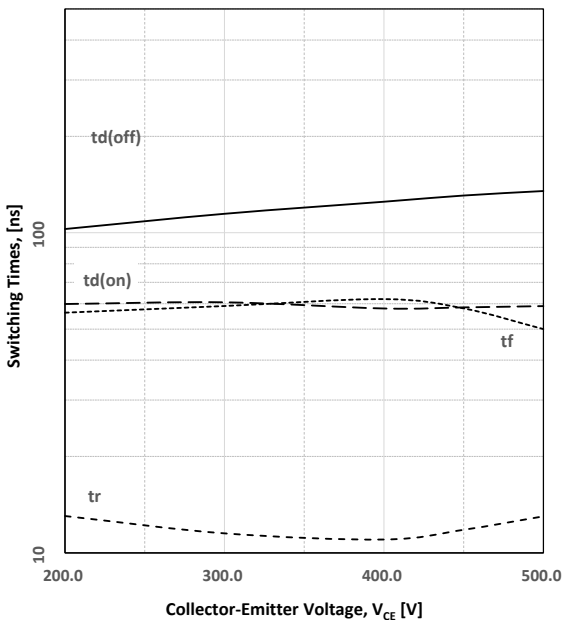

Figure.20 Switching Loss as Collector Voltage  
 ( $I_C=10A, V_{GE}=15V, R_g=10\Omega, T_J=150^\circ C$ )

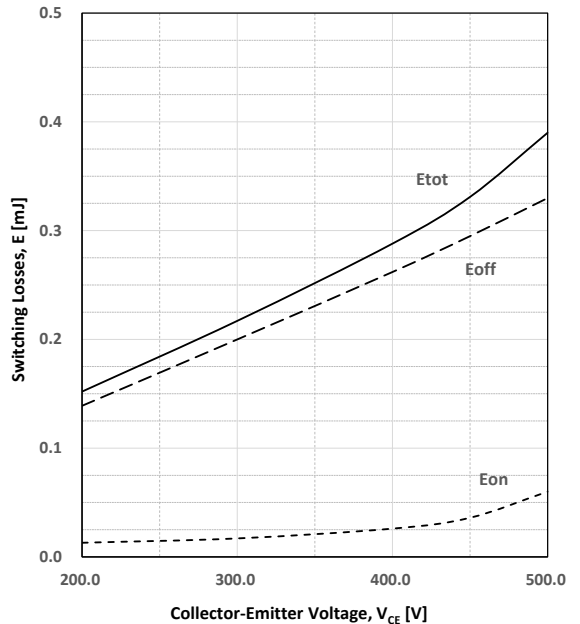

Figure.21 Switching Times as Junction Temp.  
 ( $V_{CE}=400V, I_C=10A, V_{GE}=15V, R_g=10\Omega$ )

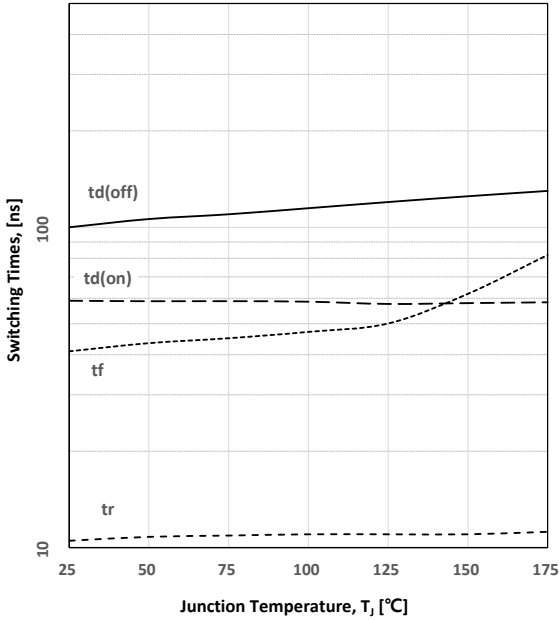
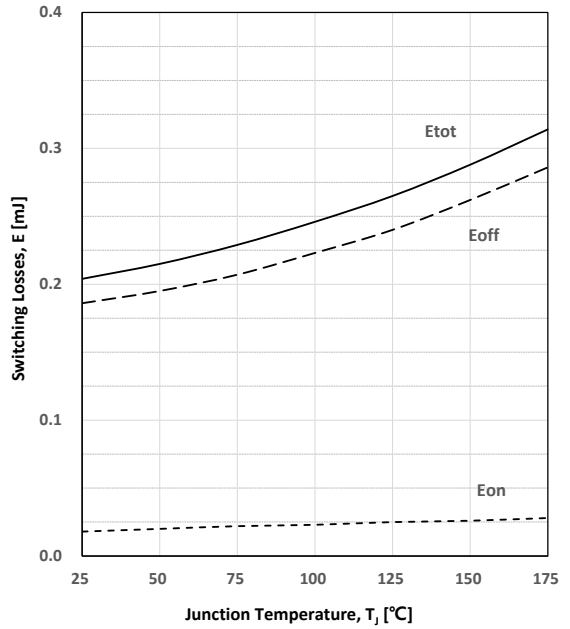
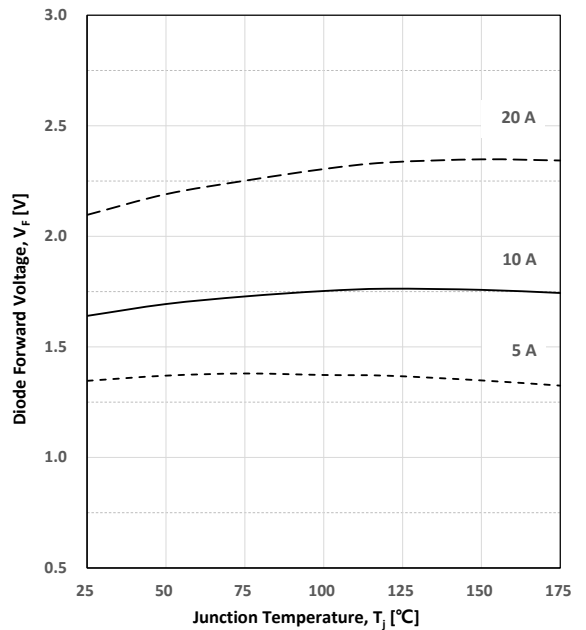
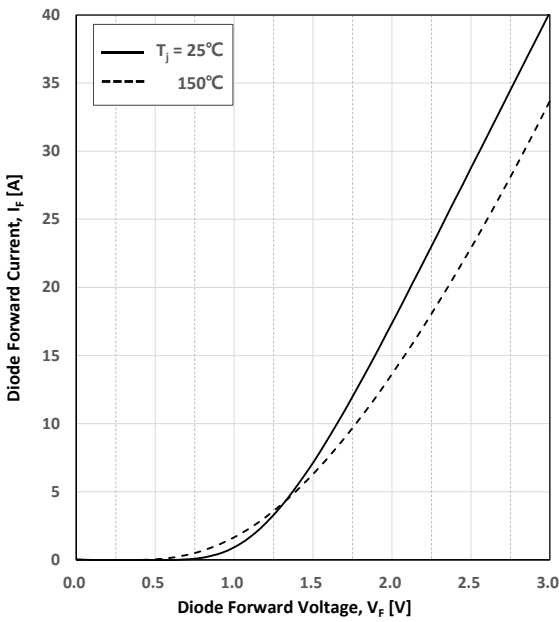

Figure.22 Switching Loss as Junction Temp.  
 ( $V_{CE}=400V, I_C=10A, V_{GE}=15V, R_g=10\Omega$ )



### Diode Static Characteristics Figure.

Figure.23 Diode Forward current characteristics as Junction Temperature and Forward current



**Diode Reverse Recovery Characteristics Figure.**

Figure.24 Reverse Recovery Current as di/dt ( $V_R=400V$ ,  $I_F=10A$ )

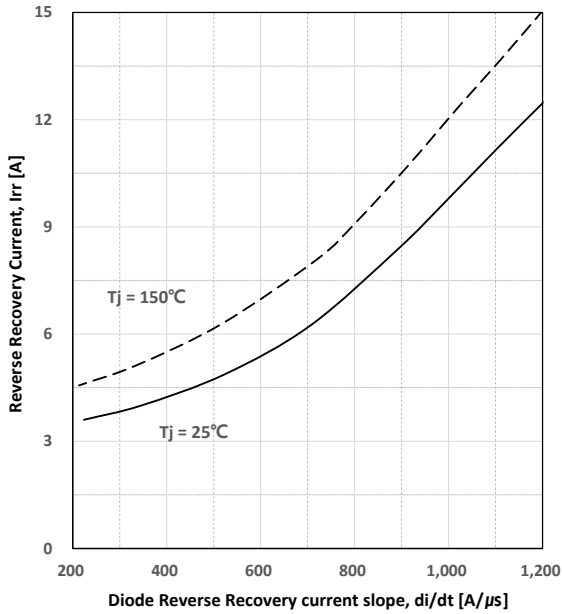

Figure.25 Reverse Recovery Time as di/dt ( $V_R=400V$ ,  $I_F=10A$ )

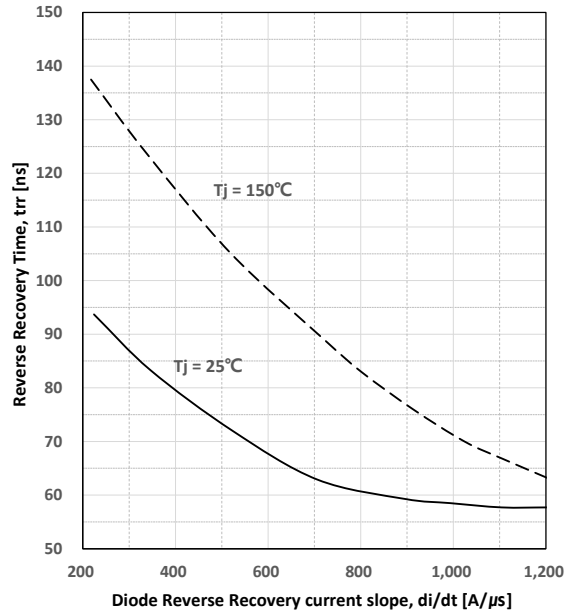
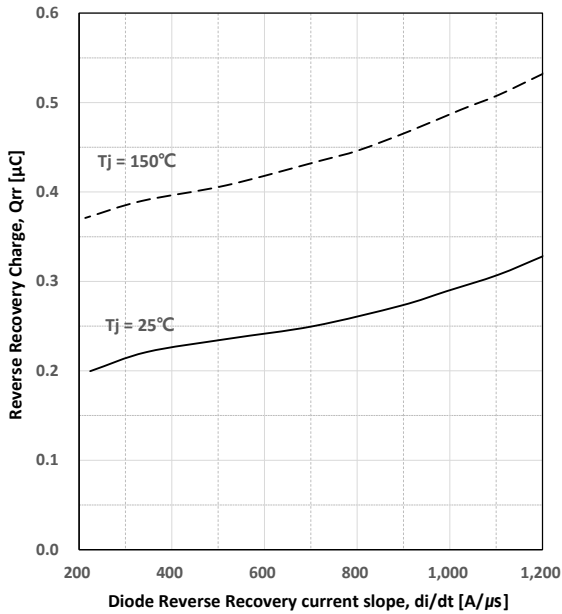
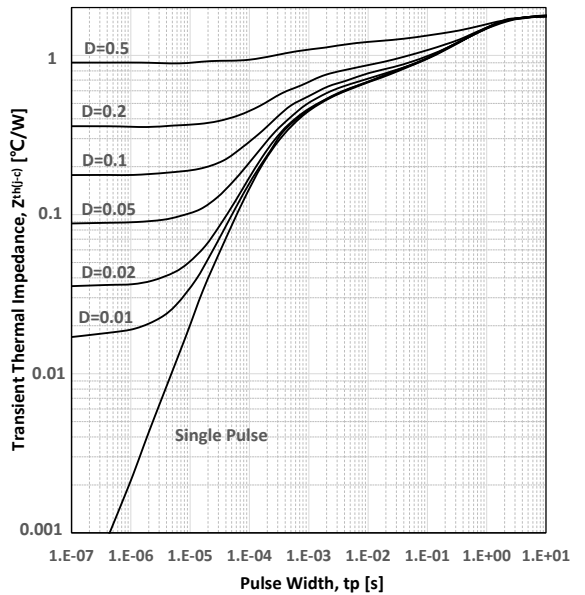

Figure.26 Reverse Recovery Charge as di/dt ( $V_R=400V$ ,  $I_F=10A$ )



**Transient Thermal Impedance Figure.**

Figure.27 IGBT Transient Thermal Impedance



Ref. 1) Switching Test Circuit

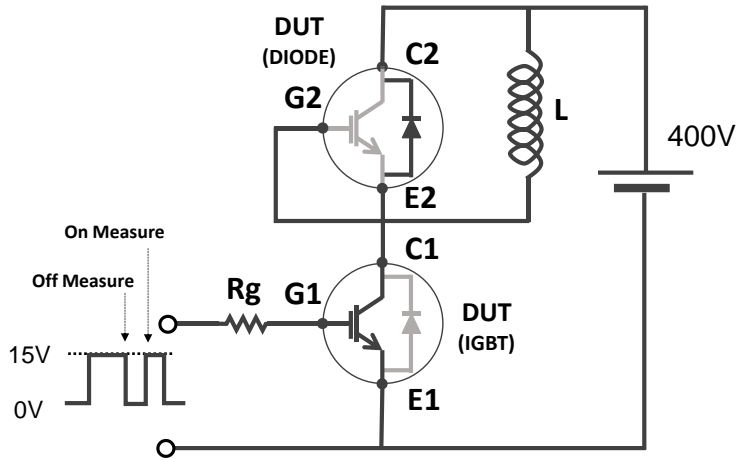

Ref. 2) Definition of switching time and loss

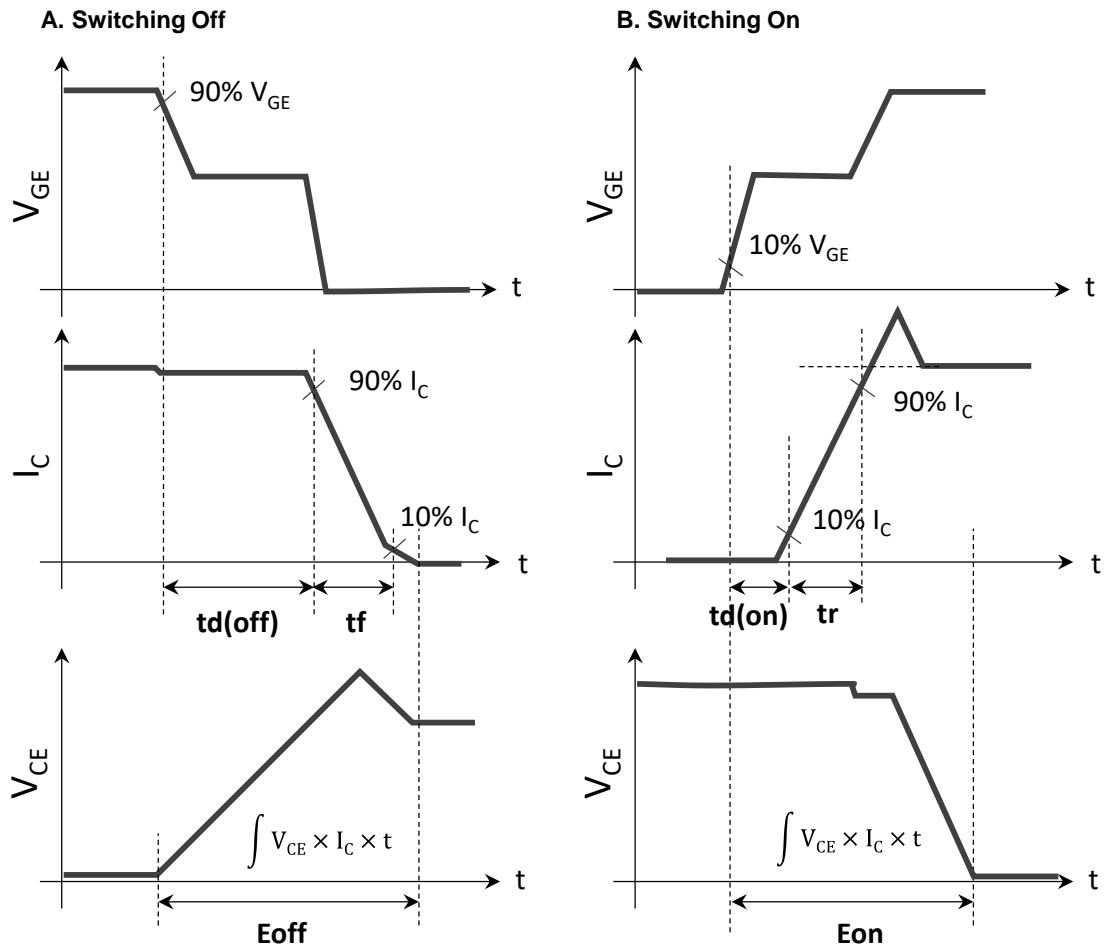

Ref. 3) Definition of Diode switching time

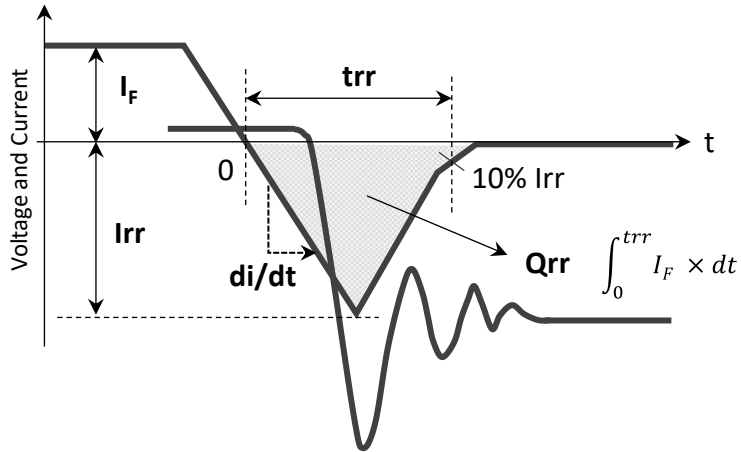

Package Dimension : D-PAK (TO-252(A))

Unit : mm

